

## Höegh Icons

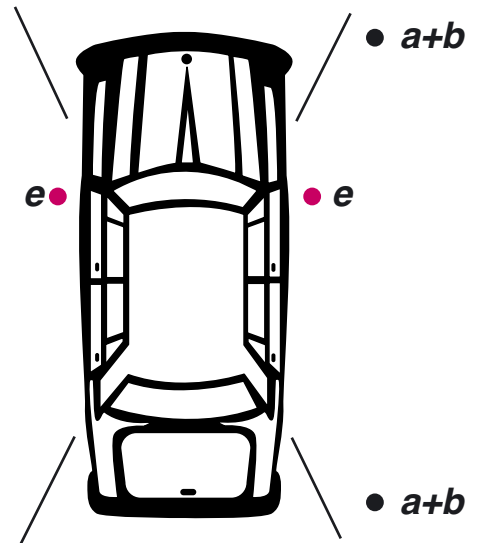

It must be ensured that the tires of the cars are located on the fixed floor of the ship during transport by sea, i.e. the tires must not be located on rings, chains etc. or have pressure contact or lateral contact with rings, chain etc.



## Lashing Instructions

- Bumper to bumper: 30 cm
- Side to side mirrors folded: 10 cm
- Side to obstruction: 15 cm
- Bumper to bulkhead: 30 cm
- Walkway: 50 cm
- Distance to emergency exit / ladders: 50 cm
- Keys to be placed in door pocket

